

INCASSO CERNIERA SUPERIORE

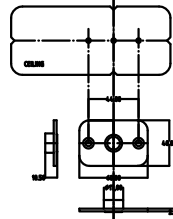

9901 SUPERIORE

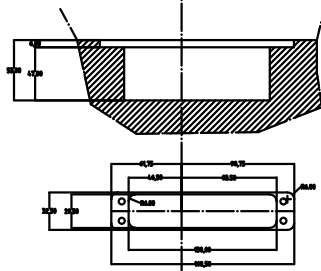
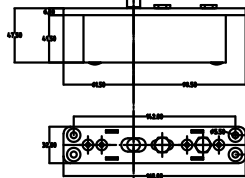

KIT 9908

ASSE DI ROTAZIONE



9908 INFERIORE



PIASTRINA MOBILE

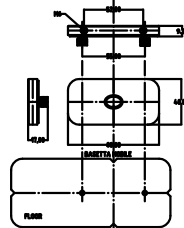

INCASSO CERNIERA INFERIORE

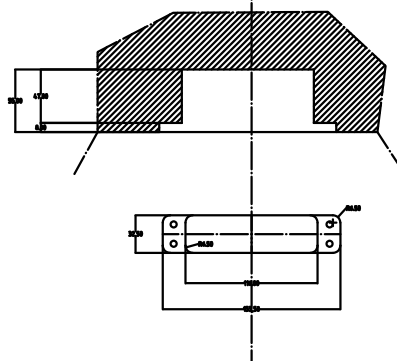

210225930